

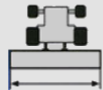







# **SERIE K** Hersees et semoirs pour tracteurs de 130 à 260 CV

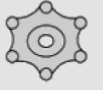

MODEL	 cm	 CV	 540 tr/mn 1000		 Nb	 cm	 Kg	 Kg	 Kg
K300	300	130-200	170/370	315	12	28	1200	1200	1400
K350	350	150-230	170/370	315	14	28	1360	1400	1620
K400	400	160-260	170/370	315	16	28	1580	1600	1890

- Lame niveleuse arrière
- Prise de force avant et arrière
- Protection latérales oscillantes
- Boîte de changement de vitesse
- Rouleau cage, à pointes , packer

- Réglage rapide du rouleau arrière
- Largeur de travail de 2,25 à 3 m
- Eléments de sécurité CE
- Options
  - Pare-pierres soudé
  - Système de changement rapide des couteaux
  - Lame niveleuse frontale
  - Cardan cat 10 avec boulon de sécurité
  - Semoir
  - Fixation hydraulique du semoir avec 2 vérins



Protection latérale



Support hydraulique du semoir

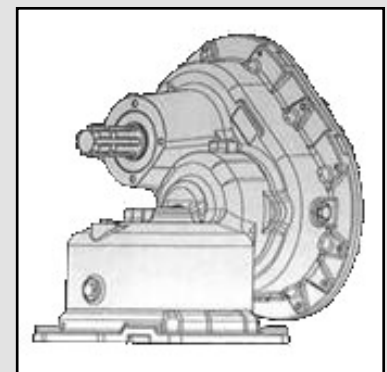

Boîte de vitesse



Système de changement rapide des couteaux

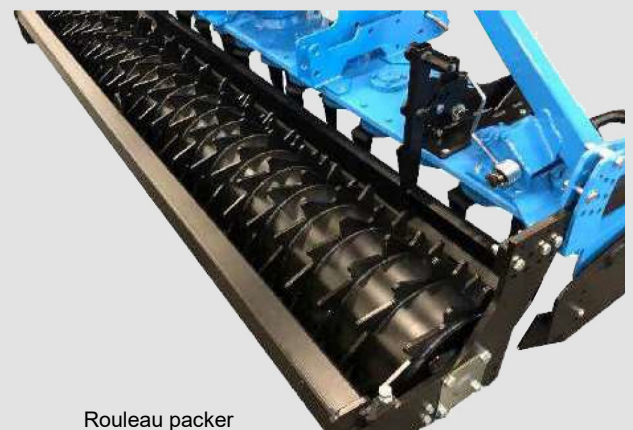

Rouleau packer

## Semoirs de 300 cm, tracteurs de 130 à 200 CV

	 (cm)	Encombrement (cm)	 (CV)	Capacité (L)	Nb de tubes de sortie
E300L	300	309	120-160	400	24

- Montage en fixe sur la herse
- Tubes de sortie avec entraineurs individuels
- Protection latérales oscillantes
- Réglage de débit
- Commande d'arrêt du semis
- Réglage rapide du rouleau arrière
- Largeur de travail de 1,25 à 2,5 m
- Éléments de sécurité CE
- Options
  - Relevage hydraulique du semoir
  - Double trémie pour semence et engrais



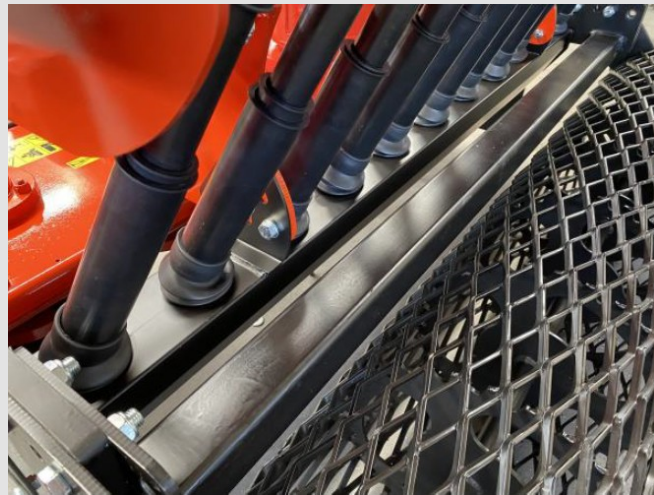

Entraineurs sur chaque tube de sortie

Votre revendeur

**KERSTEN**  
France

8 rue de la Gare - Lot N°8  
24290 Montignac Lascaux

[contact@kersten-france.fr](mailto:contact@kersten-france.fr)

[www.kersten-france.fr](http://www.kersten-france.fr)